

地毯	CR-V / Modulo
----	---------------

安装位置图

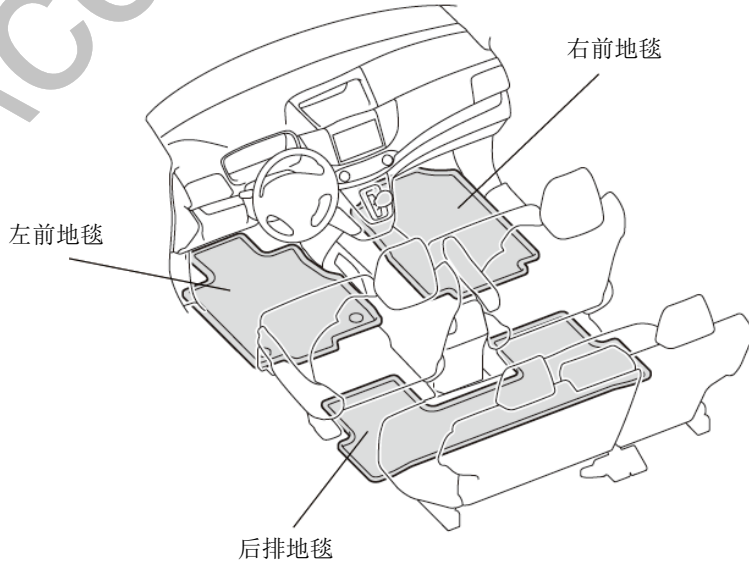

为确保安装的安全（务必仔细阅读）

警告标志的说明

- 本书中使用以下标志来标明有可能造成操作人员或其他人受伤的操作，以及有关安装的建议。



不遵从该指示，将导致死亡或者其他严重伤害



不遵从该指示，有可能导致死亡或者其他严重伤害



不遵从该指示，有可能导致受伤



防止导致故障、破损的建议



禁止事项

关于图标

- 使用下列图标来标明安装的位置和操作人员的视线角度。

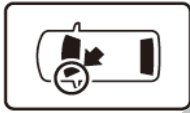

车身对应位置



仪表板对应位置

- 使用下列图标来标明操作中必须遵守的事项。



佩戴防护眼镜



双人作业



除去毛刺



保管好零件（还给客户）



使用规定扭力上紧螺丝



使用脱脂洗洁剂清洗



带皮手套



放置于纸皮箱或毛毯上



涂抹修补漆后充分干燥



用力压紧粘贴面



垂直安装面操作

组成配件

地毯套件

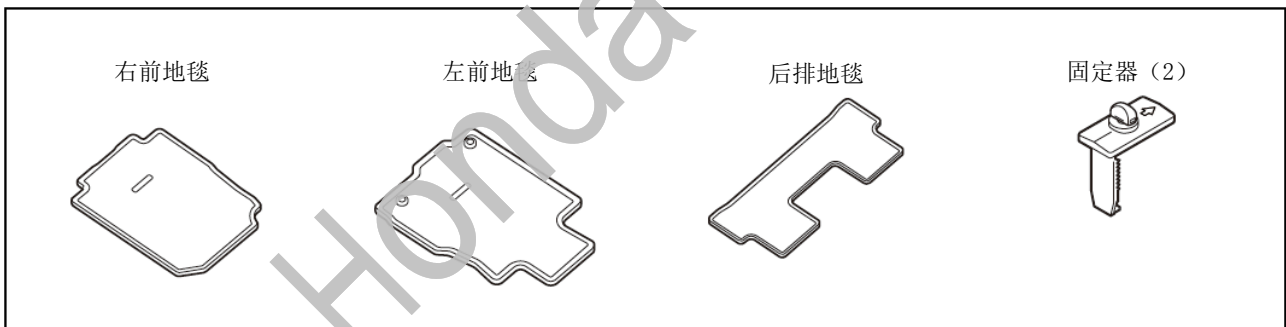

必要工具/用具

- 裁纸刀
- 一字螺丝刀

安装方法与顺序

前排地毯的安装

1. 切开车辆的地毯。

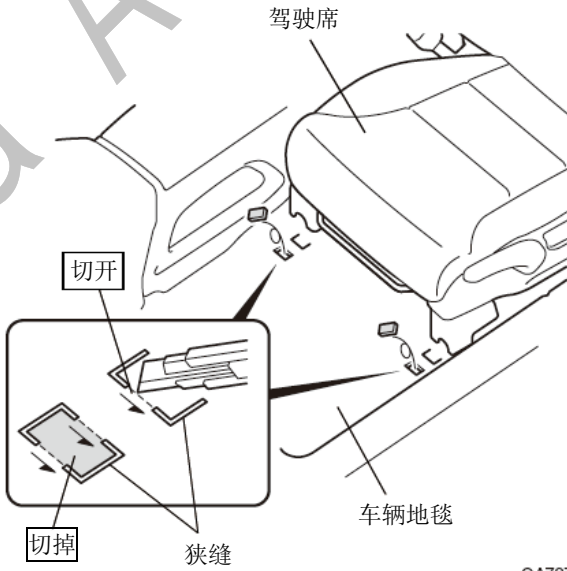

2. 安装固定器。

建议

- 不要夹住车辆地毯。
- 用一字螺丝刀顶住固定器下方一边上紧。
- 确认固定器安装牢固。

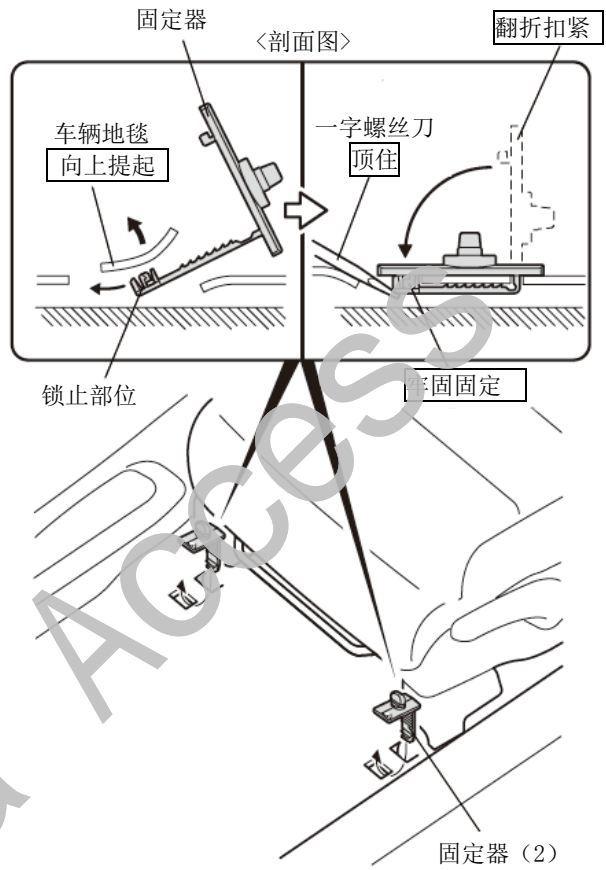

3. 安装左前地毯。

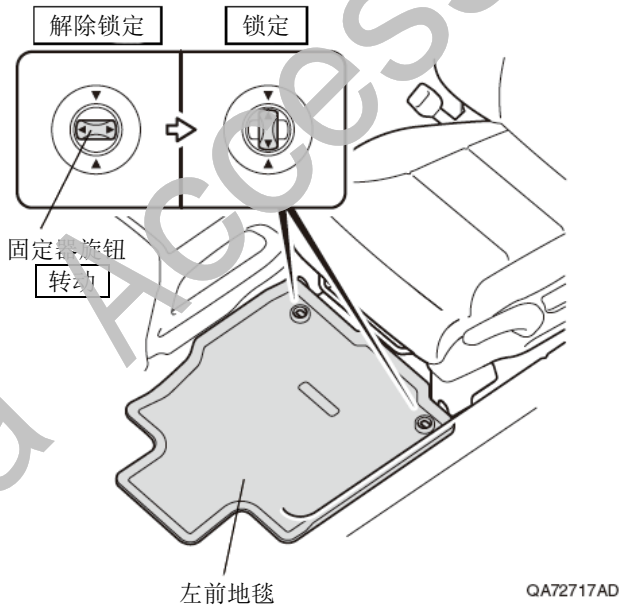

4. 铺放右前地毯。

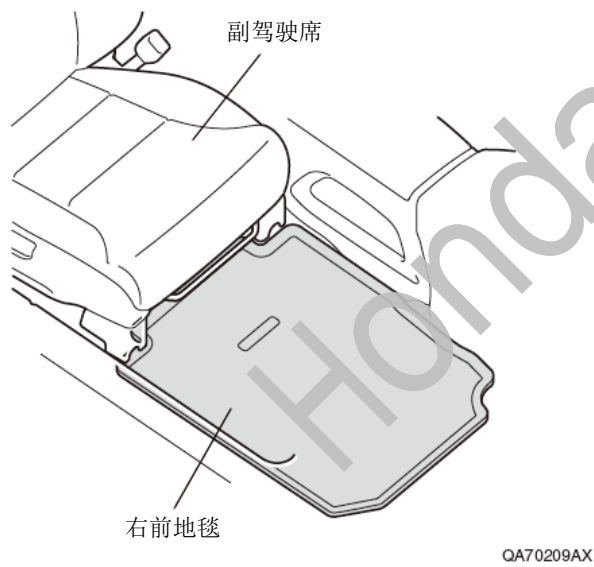
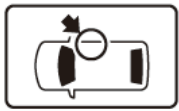

5. 铺放后排地毯。
(安装完毕)

